

---

# AXA Product List

---



# Product List [BLUEDIAMOND]

For Lifetime Smiles

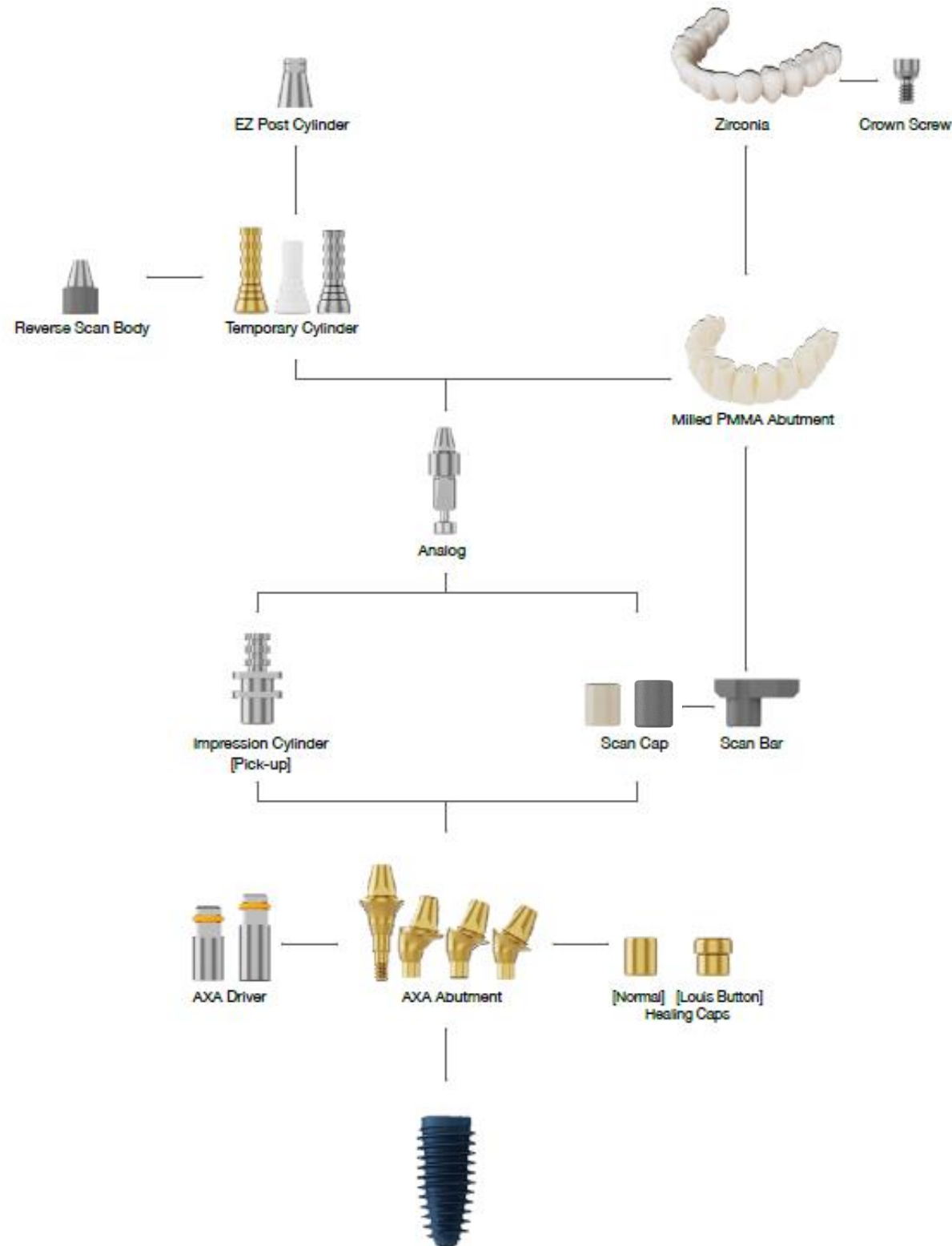

## AXA Abutment (Straight)

- Use with AXA Driver
- 1piece type
- Recommend torque: 35Ncm



NC

| Cuff Height (mm) | Ref.C        |
|------------------|--------------|
| 2                | AXBDNS52400C |
| 3                | AXBDNS53400C |
| 4                | AXBDNS54400C |
| 5                | AXBDNS55400C |

RC

| Cuff Height (mm) | Ref.C        |
|------------------|--------------|
| 2                | AXBDRS52400C |
| 3                | AXBDRS53400C |
| 4                | AXBDRS54400C |
| 5                | AXBDRS55400C |

## AXA Abutment (12°)

- Abutment Screw (AXBDAS1603/AXBDAS1604/AXBDAS1605) included
- Recommend torque: 35Ncm

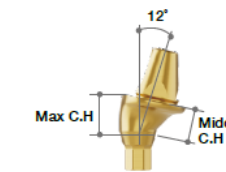

NC

| Cuff Height (mm) |        | Ref.C         |
|------------------|--------|---------------|
| Max              | Middle |               |
| 3                | 2.5    | AXBDNS53410TC |
| 4                | 3.5    | AXBDNS54410TC |
| 5                | 4.5    | AXBDNS55410TC |



RC

| Cuff Height (mm) |        | Ref.C         |
|------------------|--------|---------------|
| Max              | Middle |               |
| 3                | 2.5    | AXBDRS53410TC |
| 4                | 3.5    | AXBDRS54410TC |
| 5                | 4.5    | AXBDRS55410TC |

## AXA Abutment (20°)

- Abutment Screw (AXBDAS1603/AXBDAS1604/AXBDAS1605) included
- Recommend torque: 35Ncm

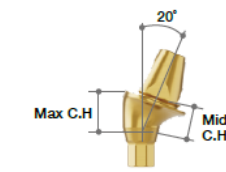

NC

| Cuff Height (mm) |        | Ref.C         |
|------------------|--------|---------------|
| Max              | Middle |               |
| 3                | 2.5    | AXBDNS53420TC |
| 4                | 3.5    | AXBDNS54420TC |
| 5                | 4.5    | AXBDNS55420TC |



RC

| Cuff Height (mm) |        | Ref.C         |
|------------------|--------|---------------|
| Max              | Middle |               |
| 3                | 2.5    | AXBDRS53420TC |
| 4                | 3.5    | AXBDRS54420TC |
| 5                | 4.5    | AXBDRS55420TC |

## AXA Abutment (30°)

- Abutment Screw (AXBDAS1603/AXBDAS1604/AXBDAS1605) included
- Recommend torque: 35Ncm

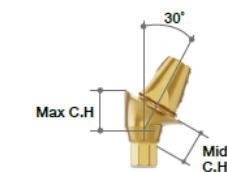

NC

| Cuff Height (mm) |        | Ref.C         |
|------------------|--------|---------------|
| Max              | Middle |               |
| 3                | 2      | AXBDNS53430TC |
| 4                | 3      | AXBDNS54430TC |
| 5                | 4      | AXBDNS55430TC |



RC

| Cuff Height (mm) |        | Ref.C         |
|------------------|--------|---------------|
| Max              | Middle |               |
| 3                | 2      | AXBDRS53430TC |
| 4                | 3      | AXBDRS54430TC |
| 5                | 4      | AXBDRS55430TC |



## [ARi]

### AXA Abutment (Straight)

- Use with AXA Driver
- 1piece type
- Recommend torque: 25Ncm

| Cuff Height (mm) |  | Ref.C        |
|------------------|--|--------------|
| 2                |  | AXARIN42400C |
| 3                |  | AXARIN43400C |
| 4                |  | AXARIN44400C |
| 5                |  | AXARIN45400C |

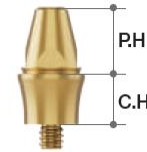

### AXA Abutment (12°)

- Abutment Screw (AXARIAS1603/AXARIAS1604/AXARIAS1605) included
- Recommend torque: 25Ncm

| Cuff Height (mm) |        | Ref.C         |
|------------------|--------|---------------|
| Max              | Middle |               |
| 3                | 2.5    | AXARIN43410TC |
| 4                | 3.5    | AXARIN44410TC |
| 5                | 4.5    | AXARIN45410TC |

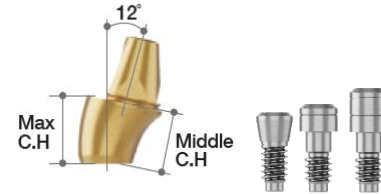

### AXA Abutment (20°)

- Abutment Screw (AXARIAS1603/AXARIAS1604/AXARIAS1605) included
- Recommend torque: 25Ncm

| Cuff Height (mm) |        | Ref.C         |
|------------------|--------|---------------|
| Max              | Middle |               |
| 3                | 2.5    | AXARIN43420TC |
| 4                | 3.5    | AXARIN44420TC |
| 5                | 4.5    | AXARIN45420TC |

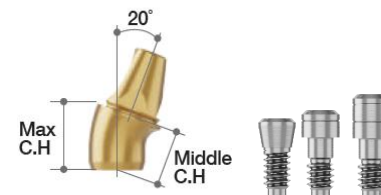

### AXA Abutment (30°)

- Abutment Screw (AXARIAS1603/AXARIAS1604/AXARIAS1605) included
- Recommend torque: 25Ncm

| Cuff Height (mm) |        | Ref.C         |
|------------------|--------|---------------|
| Max              | Middle |               |
| 3                | 2      | AXARIN43430TC |
| 4                | 3      | AXARIN44430TC |
| 5                | 4      | AXARIN45430TC |

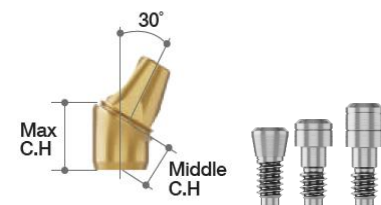

## [AnyRidge Internal]

### AXA Abutment (Straight)

- Use with AXA Driver
- 1piece type
- Recommend torque: 35Ncm

| Cuff Height (mm) |  | Ref.C       |
|------------------|--|-------------|
| 2                |  | AXARS52400C |
| 3                |  | AXARS53400C |
| 4                |  | AXARS54400C |
| 5                |  | AXARS55400C |

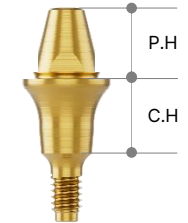

### AXA Abutment (12°)

- Abutment Screw (AXARAS1803/AXARAS1804/AXARAS1805) included
- Recommend torque: 25Ncm

| Cuff Height (mm) |        | Ref.C        |
|------------------|--------|--------------|
| Max              | Middle |              |
| 3                | 2.5    | AXARS53410LC |
| 4                | 3.5    | AXARS54410LC |
| 5                | 4.5    | AXARS55410LC |

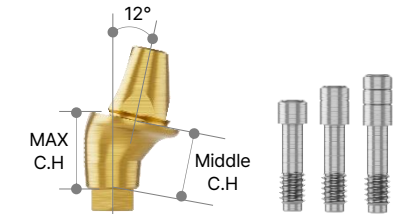

### AXA Abutment (20°)

- Abutment Screw (AXARAS1803/AXARAS1804/AXARAS1805) included
- Recommend torque: 25Ncm

| Cuff Height (mm) |        | Ref.C        |
|------------------|--------|--------------|
| Max              | Middle |              |
| 3                | 2.5    | AXARS53420LC |
| 4                | 3.5    | AXARS54420LC |
| 5                | 4.5    | AXARS55420LC |

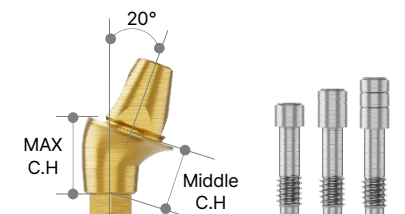

### AXA Abutment (30°)

- Abutment Screw (AXARAS1803/AXARAS1804/AXARAS1805) included
- Recommend torque: 25Ncm

| Cuff Height (mm) |        | Ref.C        |
|------------------|--------|--------------|
| Max              | Middle |              |
| 3                | 2      | AXARS53430LC |
| 4                | 3      | AXARS54430LC |
| 5                | 4      | AXARS55430LC |

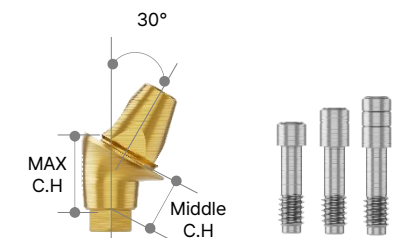

## Healing Cap

- Healing Cap Screw (AXHCS16) included
- The size of the Healing Cap is selected depending on the amount of soft tissue or type of restoration.
- Recommend torque: By Hand (5~8Ncm)

| Height (mm) | Type         | Ref.C      |
|-------------|--------------|------------|
| 6           | Normal       | AXHCS504T  |
|             | Louis Button | AXHCLS504T |

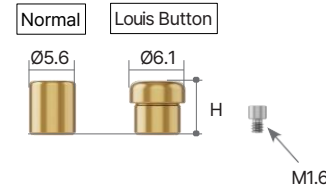

## Impression Cylinder (Pick-up)

- Guide Pin (AXGPP10) included
- Used when making impressions from the abutment level
- Recommend torque: By Hand (5~8Ncm)

| Height (mm) | Type   | Ref.C       |
|-------------|--------|-------------|
| 14.1        | Multi  | AXICS504T   |
|             | Single | AXICPS504ST |

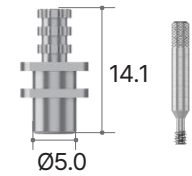

## Impression Cylinder (Transfer)

- Healing Cap Screw (AXHCS16) included
- Used when making impressions from the abutment level
- Recommend torque: By Hand (5~8Ncm)

| Height (mm) | Type   | Ref.C      |
|-------------|--------|------------|
| 6.0         | Single | AXICS504ST |



## Analog

- Analog Screw (ALS18) included
- Used instead of Multi-unit Abutment in Working Model
- Used as RP Analog in 3D Printed Working Model
- Recommend torque: By Hand (5~8Ncm)

| Profile Diameter | System | Ref.C     |
|------------------|--------|-----------|
| Ø4.2             | ARi    | AXAL404T  |
| Ø5.0             | Common | AXALS504T |

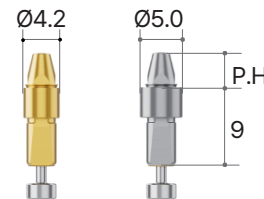

## Temporary Cylinder

- Cylinder Screw (AXCS16) included
- Used when making Acrylic Provisional Restoration
- The groove of the Post Cylinder holds the resin strongly
- Click-on Except ARi
- Recommend torque: 25Ncm

| Profile Diameter | Type     |        | Ref.C      |
|------------------|----------|--------|------------|
| Ø5.0             | Standard | Multi  | AXTCS504T  |
| Ø5.0             | Plastic  | Multi  | AXTCSP504T |
| Ø5.0             | Click-on | Multi  | AXTCS504CT |
| Ø5.0             | Standard | Single | AXTCS504ST |

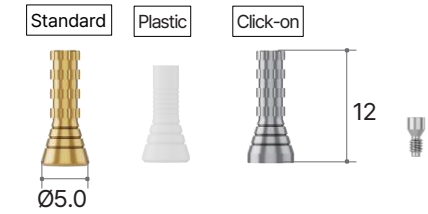

## Reverse Scan

- Cylinder Screw (AXCS16) included
- For chairside / Labside
- Supporting Dental CAD
- 3Shape / exocad / Dental Wings
- Recommend torque: by hand (5~8Ncm)

| Profile Diameter | Ref.C     |
|------------------|-----------|
| Ø5.0             | AXRSS504T |

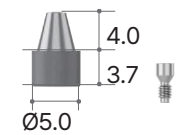

## Scan Bar

- Cylinder Screw (AXCS16) included
- For chairside / Labside
- Supporting Dental CAD
- 3Shape / exocad / Dental Wings
- Recommend torque: by hand (5~8Ncm)

| Profile Diameter | Ref.C     |
|------------------|-----------|
| Ø5.0             | AXSBS504T |

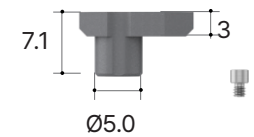

## Scan Cap

- Scan Cap Screw (AXSCSP16) included
- For chairside / Labside
- Supporting Dental CAD
- 3Shape / exocad / Dental Wings
- Recommend torque: by hand (5~8Ncm)

| Profile Diameter | Type   | Ref.C        |
|------------------|--------|--------------|
| Ø5.0             | Single | AXSCSPM504ST |
|                  | Multi  | AXSCSPM504T  |

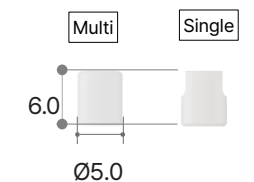

## Scan Abutment

- Healing Cap Screw (AXHCS16) included
- For chairside / Labside
- Supporting Dental CAD
- 3Shape / exocad / Dental Wings
- Recommend torque: by hand (5~8Ncm)

| Type   | Ref.C      |
|--------|------------|
| Single | AXSA4013ST |

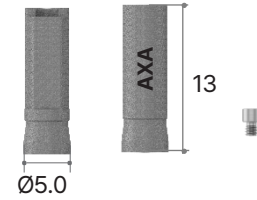

## EZ Post Cylinder

- Cylinder Screw (AXCS16) included
- Recommend torque: 25Ncm

| Profile Diameter | Type   |        | Ref.C       |
|------------------|--------|--------|-------------|
| Ø4.2             | ARi    | Multi  | AXEPC404T   |
| Ø5.0             | Common | Multi  | AXEPCS504T  |
| Ø4.2             | ARi    | Single | AXEPC404ST  |
| Ø5.0             | Common | Single | AXEPCS504ST |

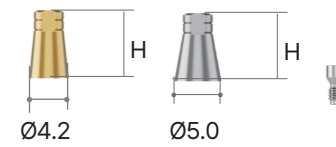

## CCM Cylinder

- Cylinder Screw (AXCS16) included
- For use with difficult customized abutment
- Can be cast with non-precious alloys (Ni-Cr, Cr-Co alloys)
- Non-precious melting temperature: depends on manufacturer
- Threaded sleeves for convenient resin / wax-up
- CCM melting temperature: 1300~1400°C
- Recommend torque: 25Ncm

| Height (mm) | Type   | Ref.C      |
|-------------|--------|------------|
| 14.5        | Single | AXCCM504ST |
| 14.5        | Multi  | AXCCM504T  |

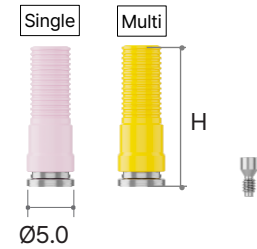

## Crown Screw

- Directly connects the crown and AXA
- 1Set = 5ea
- Recommend torque: 25Ncm

| Height (mm) | Type  | Ref.C    |
|-------------|-------|----------|
| 3.3         | Short | AXCS16SP |
| 4.5         | Long  | AXCS16LP |

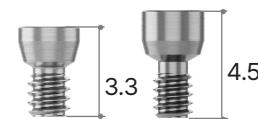

# AXA Prosthetic Kit

For Lifetime Smiles

## [BLUEDIAMOND] Ref.C [KAXBD3000S]



## [ARi] Ref.C [KAXARI3000S]

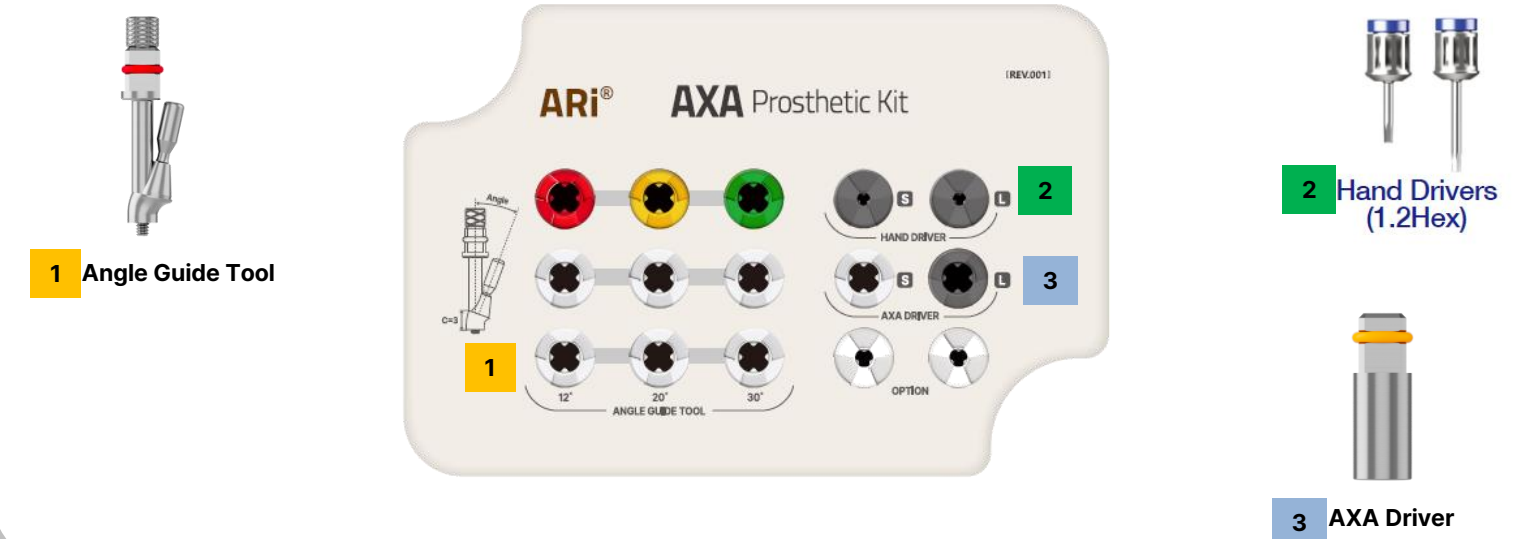

### Angle Guide Tool

When placing the implant, Angle guide tool will help keep the direction of the AXA's post path(screw hole) consistent to achieve a passive fit

| Type |     | Ref.C      |
|------|-----|------------|
| NC   | 12° | AXBDNAGT10 |
|      | 20° | AXBDNAGT20 |
|      | 30° | AXBDNAGT30 |
| RC   | 12° | AXBDRAGT10 |
|      | 20° | AXBDRAGT20 |
|      | 30° | AXBDRAGT30 |

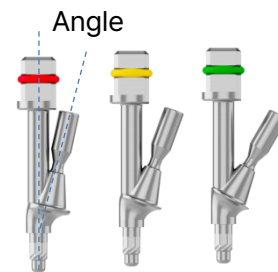

| Type | Ref.C       |
|------|-------------|
| 12°  | AXARINAGT10 |
| 20°  | AXARINAGT20 |
| 30°  | AXARINAGT30 |

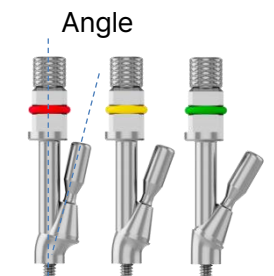

### AXA Driver (Ratchet type)

- Used when connecting AXA straight type
- Pick-up available
- (\*) Items available for separate purchase

| Length (mm) | Ref.C      |
|-------------|------------|
| 9           | AXDR320S * |
| 15          | AXDR320L   |

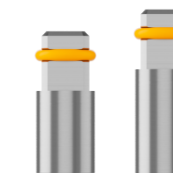

## [AnyRidge]

Ref.C [KAXAR3000S]



1 Angle Guide Tool



2 Hand Drivers (1.2Hex)



3 AXA Driver

### Angle Guide Tool

When placing the implant, Angle guide tool will help keep the direction of the AXA's post path(screw hole) consistent to achieve a passive fit

| Type | Ref.C     |
|------|-----------|
| 12°  | AXARAGT10 |
| 20°  | AXARAGT20 |
| 30°  | AXARAGT30 |

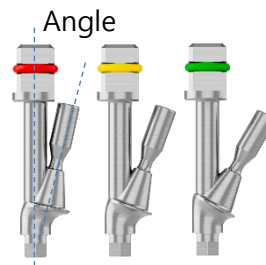

# AXA Selection Kit

For Lifetime Smiles

## Basic Configuration(16ea)

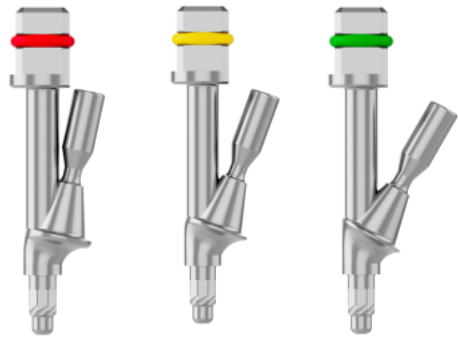

[Angle Guide Tool] X 2



[Hand Driver] X1

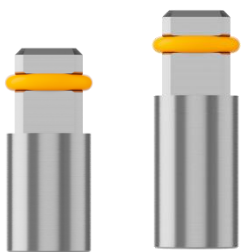

[AXA Driver] X 1

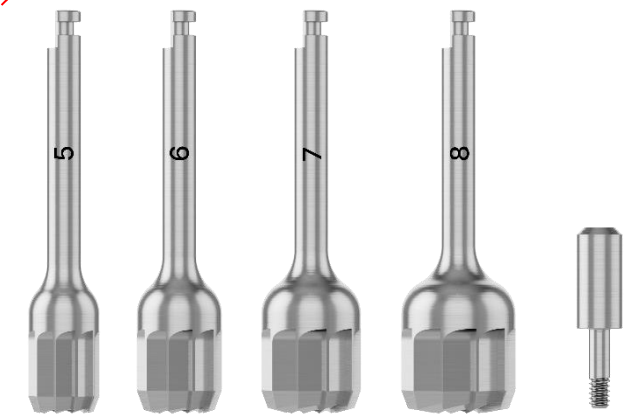
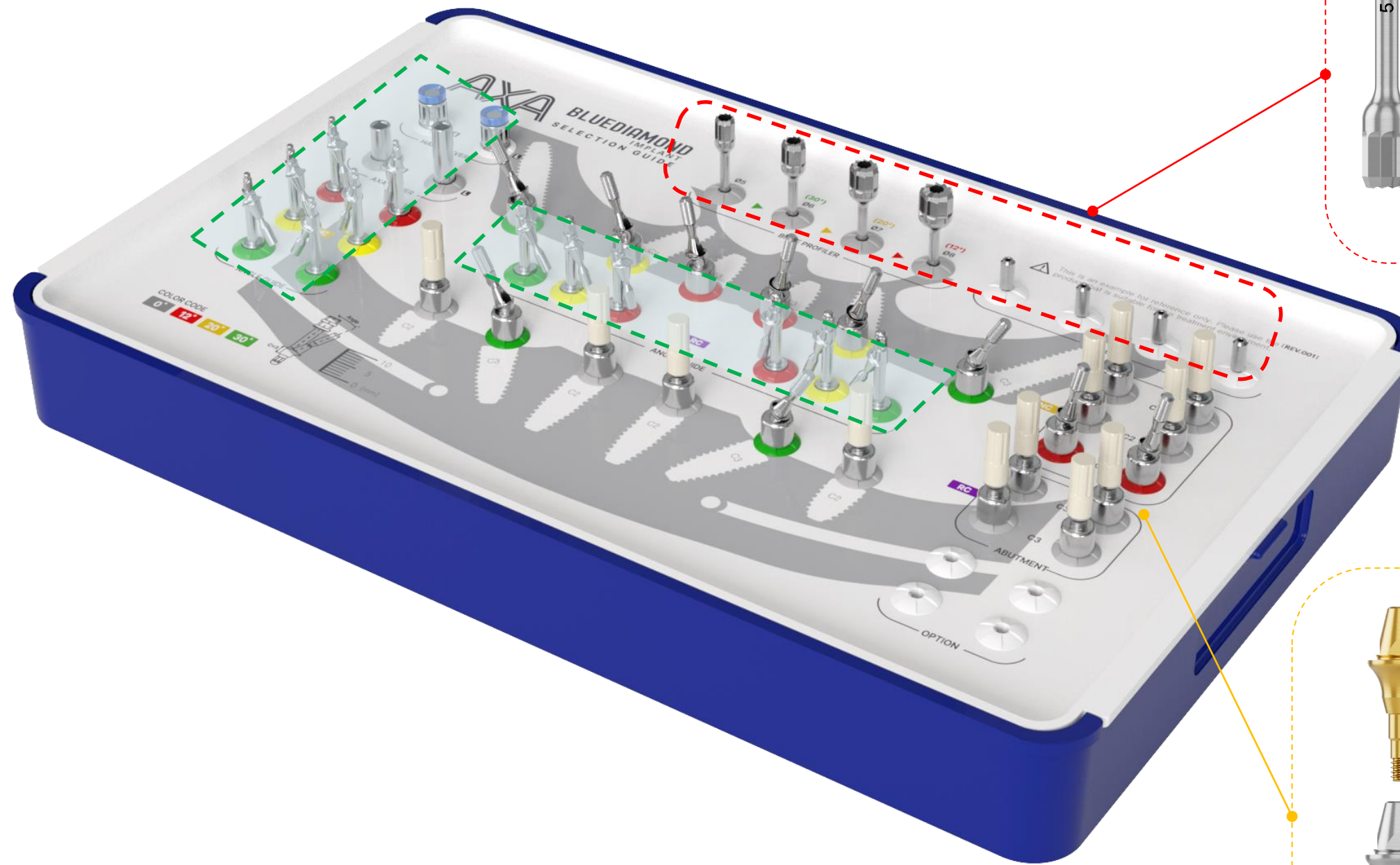

Bone Profiler Drill (Option)

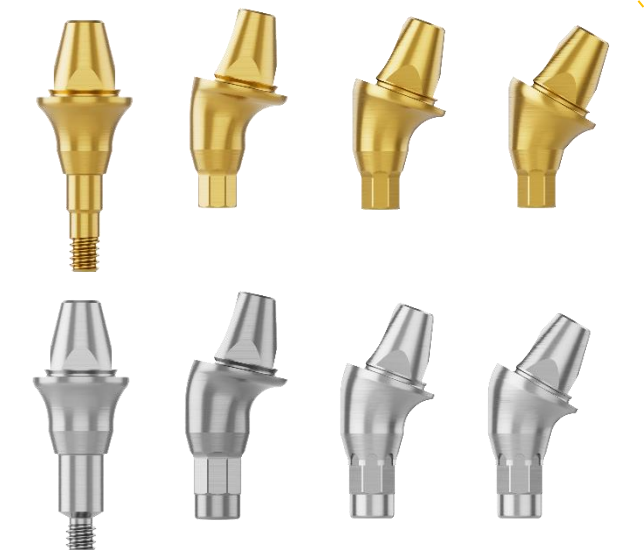

AXA (Option)



# AXA Selection Kit

Angle Guide Tool : 2set  
 AXA Drier (Short, Long) : 1set  
 Hand Driver (Short, Long) : 1set

For Lifetime Smiles

## BLUEDIAMOND

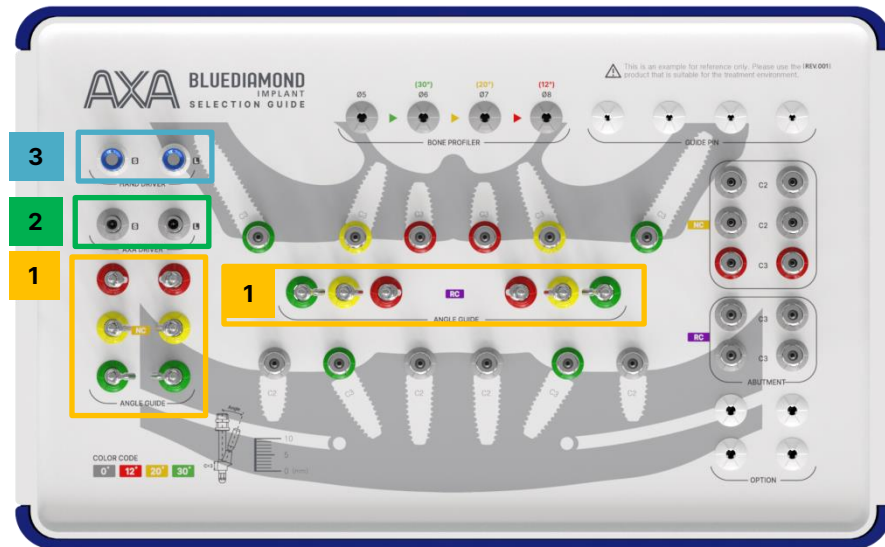

[MKAXSBD3000L]

### 1 Angle Guide Tool

| Type |     | Ref.C      |
|------|-----|------------|
| NC   | 12° | AXBDNAGT10 |
|      | 20° | AXBDNAGT20 |
|      | 30° | AXBDNAGT30 |
| RC   | 12° | AXBDRAGT10 |
|      | 20° | AXBDRAGT20 |
|      | 30° | AXBDRAGT30 |

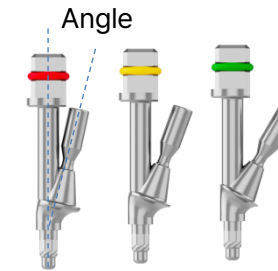

### 2 AXA Driver

| Length (mm) | Ref.C    |
|-------------|----------|
| 9           | AXDR320S |
| 15          | AXDR320L |

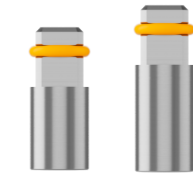

### 3 Hand Driver

| Length (mm) | Ref.C      |
|-------------|------------|
| 10          | TCMHDS1200 |
| 15          | TCMHDL1200 |



## ARi

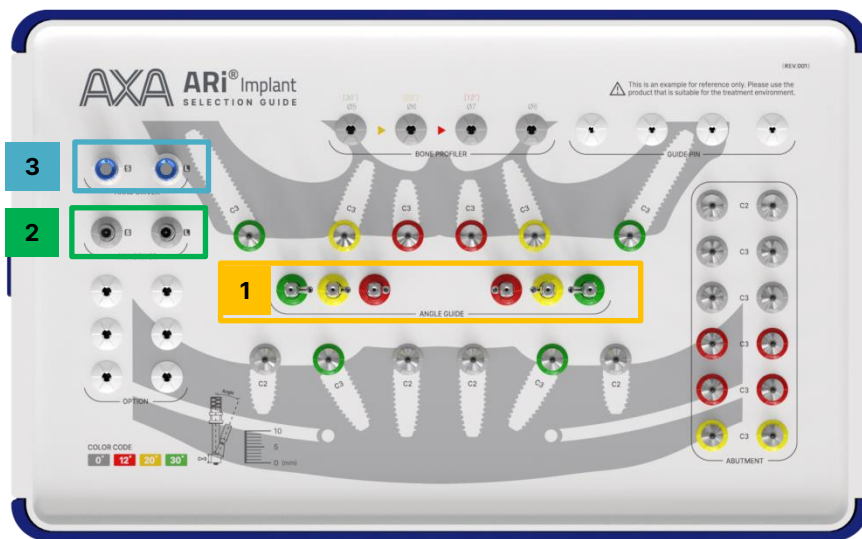

[MKAXSARI3000L]

### 1 Angle Guide Tool

| Type | Ref.C       |
|------|-------------|
| 12°  | AXARINAGT10 |
| 20°  | AXARINAGT20 |
| 30°  | AXARINAGT30 |

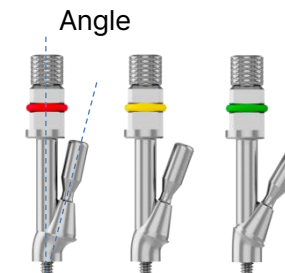

### 2 AXA Driver

| Length (mm) | Ref.C    |
|-------------|----------|
| 9           | AXDR320S |
| 15          | AXDR320L |

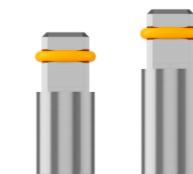

### 3 Hand Driver

| Length (mm) | Ref.C      |
|-------------|------------|
| 10          | TCMHDS1200 |
| 15          | TCMHDL1200 |



## AnyRidge Internal

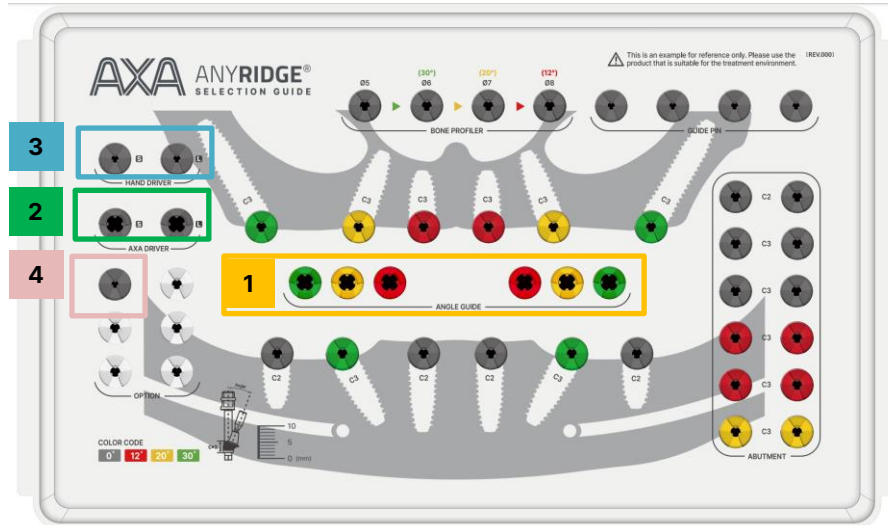

[MKAXSAR3000L]

### 1 Angle Guide Tool

| Type | Ref.C     |
|------|-----------|
| 12°  | AXARAGT10 |
| 20°  | AXARAGT20 |
| 30°  | AXARAGT30 |

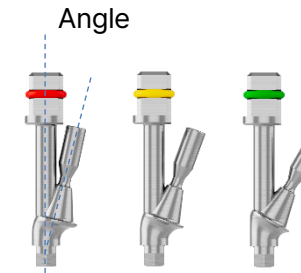

### 2 AXA Driver

| Length (mm) | Ref.C    |
|-------------|----------|
| 9           | AXDR320S |
| 15          | AXDR320L |

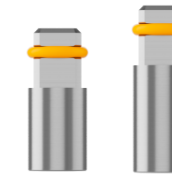

### 3 Hand Driver

| Length (mm) | Ref.C      |
|-------------|------------|
| 10          | TCMHDS1200 |
| 15          | TCMHDL1200 |



### 4 Abutment Removal Driver

| Length (mm) | Ref.C    |
|-------------|----------|
| 25.0        | TANMRD25 |



## [Option] Bone Profiler

When AXA fastening is not possible due to interference with surrounding bone  
 Use after fastening Bone Profiler Guide Pin to implant first  
 Need to change Bone Profile Guide Pin depending on system  
 Includes Bone Profiler Drill + Guide Pin

Bone Profiler Drill

Guide Pin

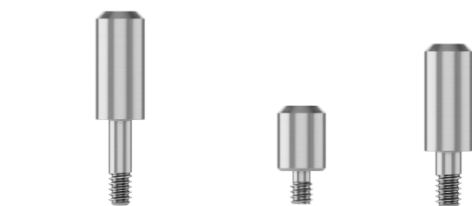
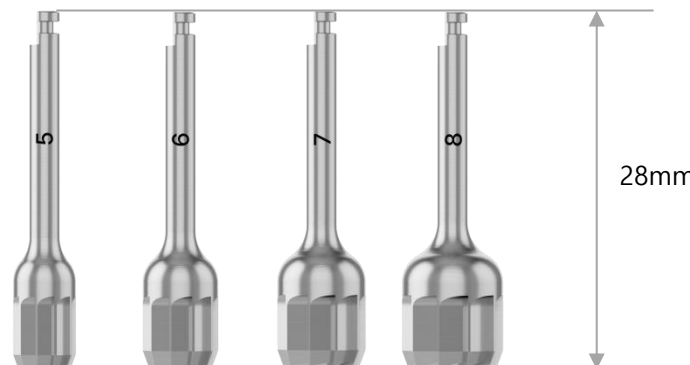

[BLUEDIAMOND]

[ARi]

[AnyRidge]

## BLUEDIAMOND

Guide Pin (BDBPGP) included

| Profile Diameter | Ref.C   |
|------------------|---------|
| Ø5.0             | BDBP50G |
| Ø6.0             | BDBP60G |
| Ø7.0             | BDBP70G |
| Ø8.0             | BDBP80G |

## ARi

Guide Pin (ARIBPGP33) included

| Profile Diameter | Ref.C    |
|------------------|----------|
| Ø5.0             | ARIBP50G |
| Ø6.0             | ARIBP60G |
| Ø7.0             | ARIBP70G |
| Ø8.0             | ARIBP80G |

## AnyRidge Internal

Guide Pin (ARBP GP) included

| Profile Diameter | Ref.C   |
|------------------|---------|
| Ø5.0             | ARBP50G |
| Ø6.0             | ARBP60G |
| Ø7.0             | ARBP70G |
| Ø8.0             | ARBP80G |

## Guide Pin

| System      | Ref.C     |
|-------------|-----------|
| AnyRidge    | ARBP GP   |
| BLUEDIAMOND | BDBPGP    |
| ARi         | ARIBPGP33 |

